

QSK Conversion of the Ameritron ALS-600 and ALS-500 HF Amplifiers

Phil Salas – AD5X

Introduction

I've had a previous QSK conversion article for the ALS-600 on this website for awhile. During this time I've received inquiries as to whether this same modification could be applied to the ALS-500 as well. I pulled the ALS-500 schematic and parts list and found that Ameritron uses the same open frame relay in both amplifiers, with the exact same wiring. This 15ms (typical) slow operating open-frame relay means that even when operating semi-break-in CW, hot switching of the transceiver can occur with either amplifier. Now unlike the ALS-600, in the ALS-500 mobile environment CW operation with or without QSK is probably not that big of an issue. However, replacing the open-frame relay with sealed relays can only improve relay reliability. Also, some hams use the ALS-500 for home and/or portable operation with an AC power supply – and so the ability to operate CW and QSK in these situations may be desirable.

Because of the ALS-500/ALS-600 power levels and maximum tolerated SWR, very fast miniature signal relays can be used for amplifier switching. For example, at 600 watts output into 50 ohms the amplifier output relay needs to carry 3.5-amps. The worst-case current for a 2:1 SWR (the point where the ALS-600 protects itself) is just under 5-amps. By paralleling two sets of contacts for the amplifier output relay, 6-amps of current carrying capacity is available which is more than sufficient for the ALS-600. These relays can also handle 1000V RMS between open contacts and between the contacts and coil which is also more than sufficient for the worst case 2:1 SWR condition at 600 watts.

The internal QSK solution

With miniature signal relays, the ALS-500/600 QSK design and implementation becomes very simple. The existing open-frame T/R relay is simply replaced with a pc-board assembly consisting of a pair of signal relays (Figure 1 below).

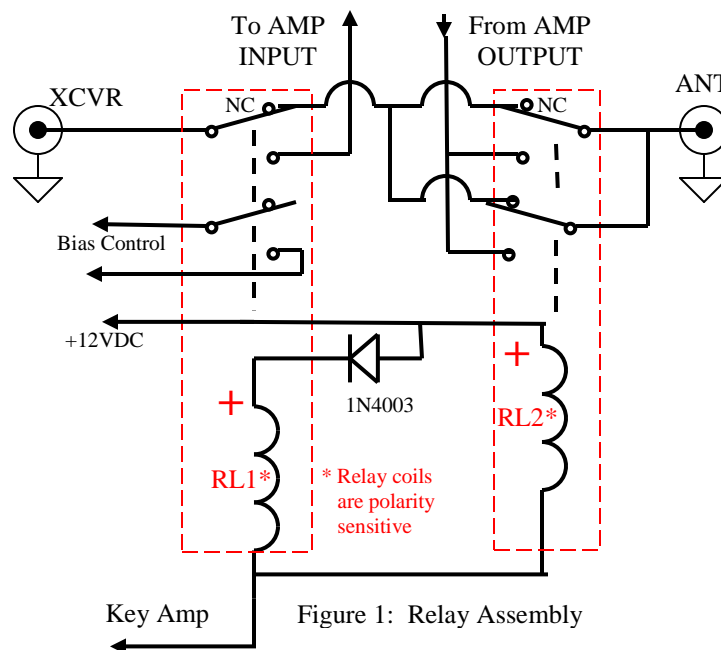

Note that the relay coil is polarity sensitive (pin 1 is positive and pin 16 is negative). One relay controls the transceiver output and amplifier bias switching, and the second relay (with paralleled contacts) controls the amplifier output switching. With operate-and-release times of approximately 3-milliseconds these signal relays switch faster than the amp-enable-to-RF output delay of most transceivers – perfect for QSK operation. As an example, I measured the amp enable-to-RF output time delay of an IC-7000 at 8-10ms, and 12-15ms for an IC-706MKIIG. The Yaesu MKV has a default delay of 5ms (adjustable from 0-30ms) and my Elecraft K3 has a delay of 8ms. The published delay information on the TS-480 and TS-2000 is 10ms, and the TenTec Omni VII and Orion published delay is 15ms. So the 3ms relay switching time ensures that the relays fully operate prior to RF becoming available for these radios. But just to make sure there is no possibility of hot-switching the amplifier, a diode in-series with the transceiver/bias relay's control voltage input gives a very slight enable delay and early drop-out delay for this relay. This ensures that the amplifier is always connected to the antenna prior to RF being applied and removed.

Construction

The complete parts list is shown in Table 1. A partial parts kit (assembled pc board, 24 & 20 gauge bus wire and the ½” heat-shrink tubing) is available from ad5x@arrl.net for \$20 ppd. The relays must be ordered separately.

Since the new relay board assembly replaces the existing ALS-500/600 T/R relay, you must remove most of the existing open frame relay leaving just the relay plastic base with its pc-mounted pins. The photos below show the original open-frame relay mounted in the ALS-600 and ALS-500 amplifiers.

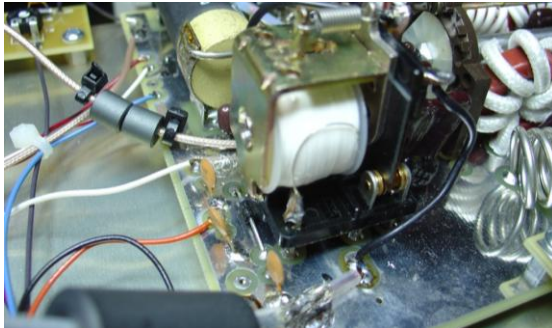

Original open-frame relay in ALS-600

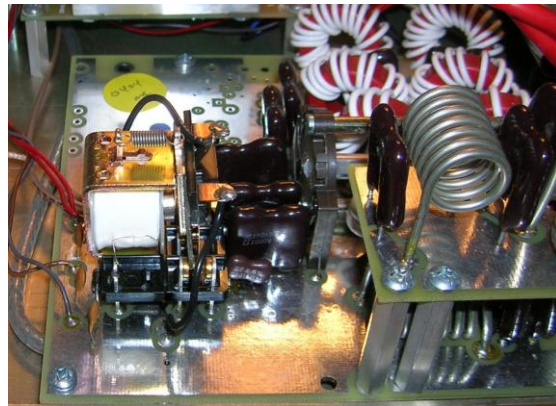

Original open-frame relay in ALS-500

The installation instructions are as follows:

- 1) Remove the open frame relay, leaving just the relay base and its PC-mount pins. To do this, cut all relay wires, including the relay coil wires, where they are soldered to the relay terminals. Leave the black RF input and RF output wires as long as possible and soldered to the main PC board. Next, unhook one end of the small relay spring and remove the movable relay contact assembly. Grab the metal frame of the relay with needle nose pliers and bend the frame back and forth. In less than a minute the

screw attaching the relay coil bracket to the plastic base will strip out of the bracket letting the coil and bracket come off the base. Put hot glue or epoxy over this screw so it doesn't rattle around (the screw is too long to pull out from under the relay base).

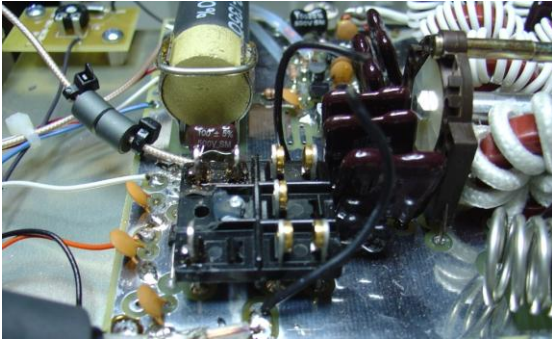

Relay base after relay removal (ALS-600)

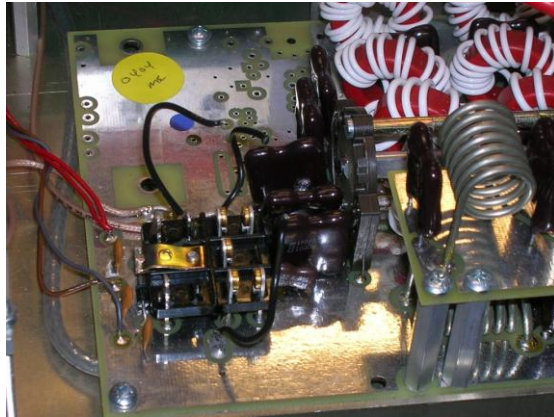

Relay base after relay removal (ALS-500)

- 2) Solder four 4" lengths of 24-gauge bus wire to the DC & bias relay posts, and four 4" lengths of 20-gauge bus-wire to the four RF relay posts. Orient the wires vertically and add a 1/2" length of sleeving over the middle bias wire. See below.

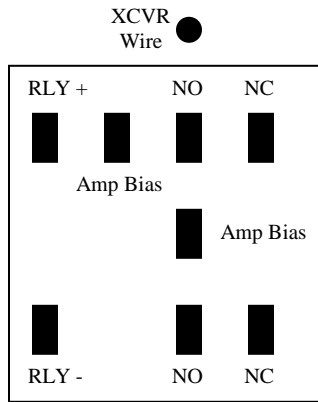

Top View: Relay Base & connections

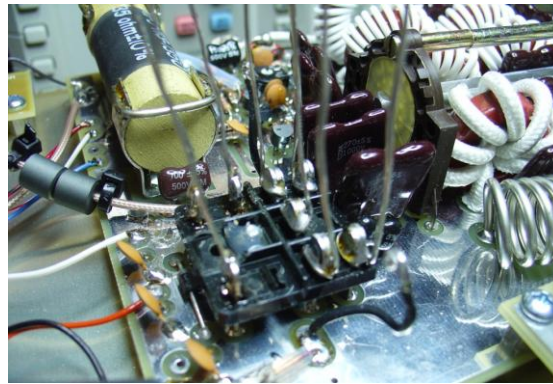

Relay base with wires attached (ALS-600)

- 3) Solder the two 16-pin IC sockets and the 1N4007 diode to the PC board.
IMPORTANT: Orient the diode band and sockets as shown in Figures 1 and 2 below.

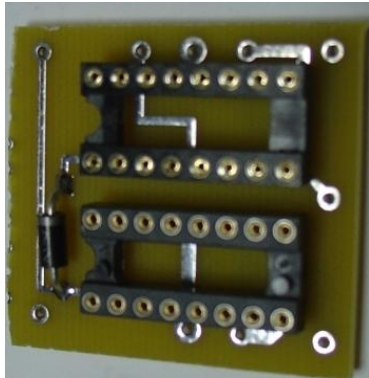

PC assembly without relays

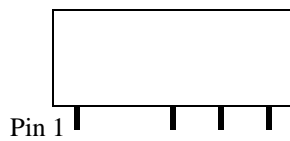

Figure 2: Side view of relay. Orient with pins positioned as shown here, and in Figure 1.

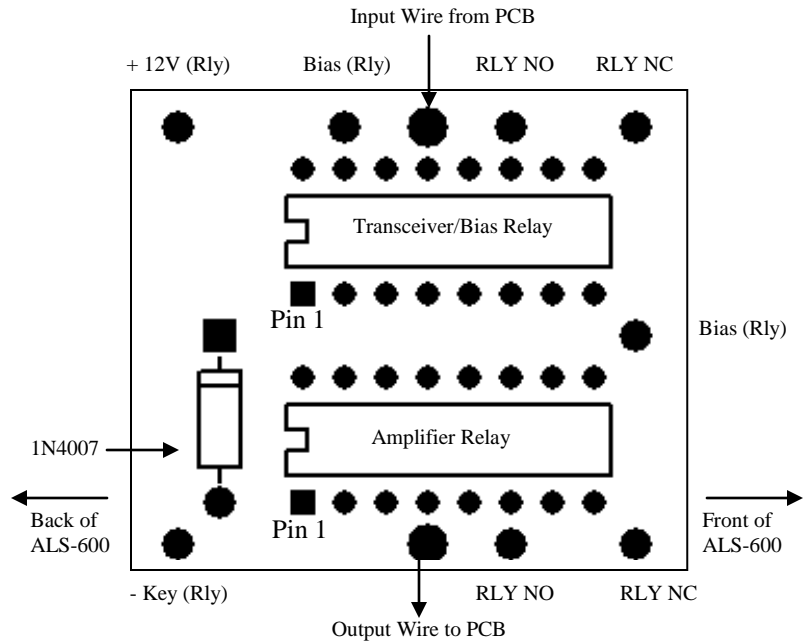
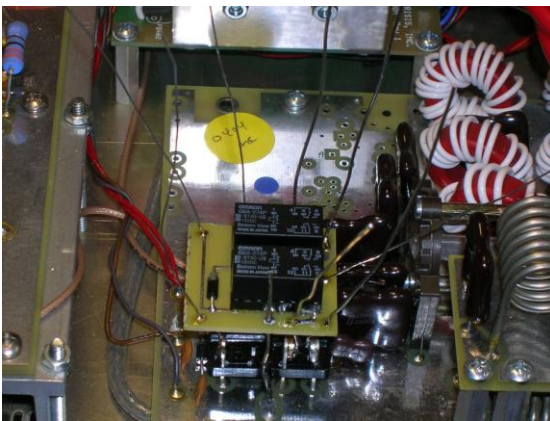

Figure 1: PC Board Wiring Interfaces – Top View

- 4) Referring to Figure 1 above, slide the relay assembly over the wires. The right-side “bias” wire from the bias relay post will need to be bent over slightly to reach the right-side “bias” hole on the PC board (that is why sleeving is added to this wire). The photo below shows the pc board assembly slid in place on the ALS-500



- 5) Minimize clearance between the bottom of the PC board and the relay pins, but ensure the wires stay straight and are not shorted to each other or the PC board.
- 6) Strip the ends of the input/output black wires from the main ALS-600/500 pc board (RF in/out black wire-ends originally attached to the relay). Twist the strands tightly. Do not tin the wires. Feed these wires into the “Input Wire” and “Output Wire” holes from the bottom of the pc board (Figure 1). Solder both wires to the pc board.
- 7) Clip excess bus wire lengths and solder all wires in place. Insert relays, orienting the relay with Pin 1 as shown in Figures 1 and 2. See the photos below for pictures of the

QSK assembly mounted in the original ALS-600, the “new” remote controllable ALS-600, and the ALS-500.

Note: I’ve used both OMRON (black) and Panasonic/Matsushita (orange) relays. However, I only recommend the OMRON relays called out in the parts list now as they are more readily available and have a faster switching speed.

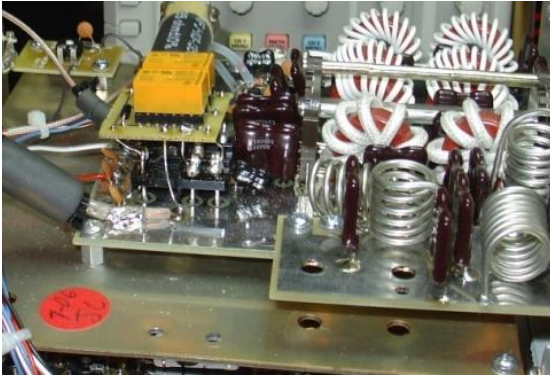

QSK assy mounted in “old” ALS-600

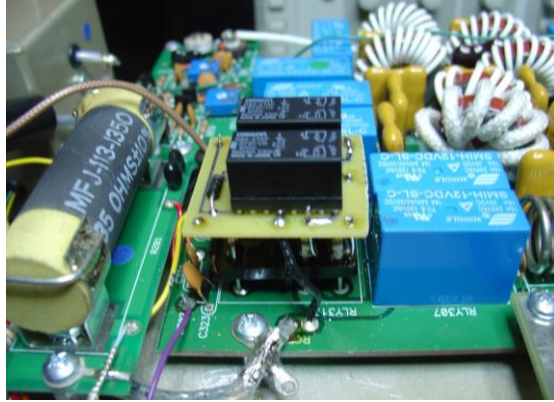

QSK assy mounted in “new” ALS-600



QSK assembly in ALS-500

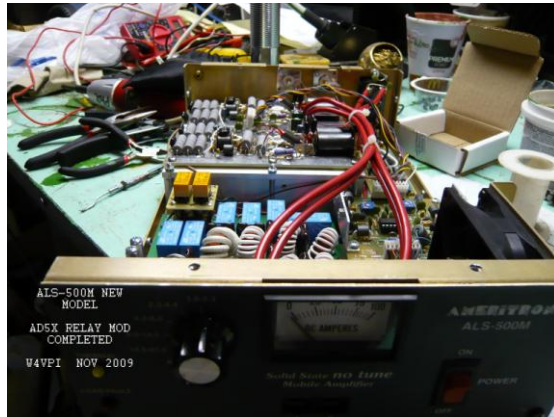

QSK Mod in W4VPI's ALS-500

Timing Measurements

Prior to installing the relay board, I measured the relay timing just to make sure everything worked as required. In the first photo below, the upper trace is the triggering (keying) signal and the lower trace is the relay response. I inverted the keying signal so that it is positive going. As you can see, the relay operates 2-3ms after the keying signal is presented, and releases about 3-4ms after the keying signal is terminated. The second photo below shows the relationship between the amplifier switching relay (yellow trace) and the transceiver/bias switching relay (blue trace). You can see the desired timing differences between the two relays due to the diode discussed earlier. The equivalent CW keying speed is approximately 80WPM.

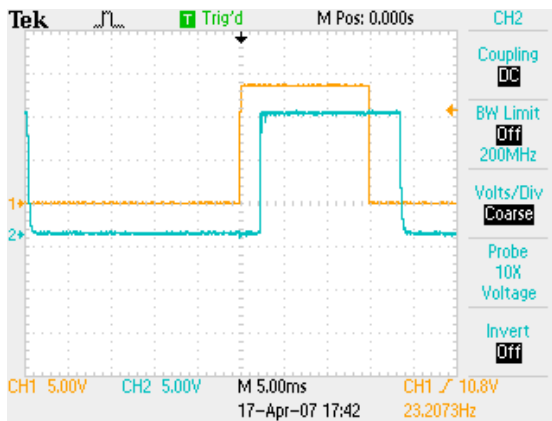

Yellow: Key. Blue: Relay response

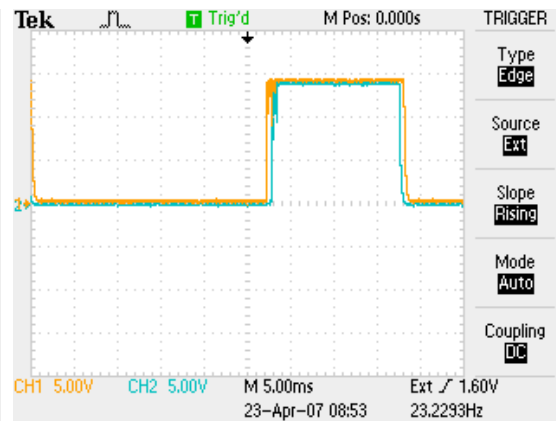

Yellow: Amp relay. Blue: Xcvr relay

QSK Drop-out Time Cautions

Most transceivers take 3-6ms for the RF to decay when you release the key, and do not un-key the amplifier until AFTER this has occurred. A few transceivers do un-key the amplifier BEFORE the transceiver's RF has decayed to zero, which means that you can hot-switch the amplifier when the transceiver un-keys the amplifier. These transceivers include the ICOM IC-706/7000 (RF persists 4.5-5.5ms after un-keying the amplifier), and TenTec Omni V/VI (RF persists ~10ms after un-keying the amplifier if you use the TX OUT-TX EN output for keying). There is no problem with this delay if you use the relay output of the Omni V/VI transceivers, but this relay output wasn't really designed for QSK operation with amplifiers. Therefore, you should only operate semi-break-in CW with the IC-706/7000, and Omni V and Omni VI transceivers. As an alternative, see the ALS-600 internal keying interface article elsewhere on this website. That interface provides a low current keying interface (ground or +12V keying), and added turn-off delay for those transceivers with a premature amp-disable output.

How Long will the Relays Last?

What kind of life can you expect from the relays? The relay life is specified at 100 million operations minimum at 36,000 operations/hour. The service life increases as the operations/hour decreases. So let's use the standard PARIS text that is used for determining code speed.

PARIS has 10 dits and 4 dahs = 14 relay operations/minute at 1 WPM.

Assuming an average of 25WPM code speed, you would have 360 relay operations per minute. So, 100 million operations = 4630 hours. Now you normally operate 50% transmitting and 50% receiving during a QSO, so your relay operating time should double to 9260 hours. There are 8760 hours/year, which means you could operate 1.057 years at 25 WPM before the relays exceeded their lifetime spec – IF you operate 24 hours/day! But when you operate, you are probably listening more like 75% of the time and in a QSO 25% of the time. So this says that your relay operating life will be over 4-years if you operate 24 hours/day. So what do you normally average in operating time/day? I bet it is not more than about an hour/day. But let's say you average 4-hours/day of operation (i.e. you are not married and have no kids, you don't shop or eat

or sleep much, and you don't hold a full-time job). So the relay life will extend to about 25 years! The bottom line - Don't worry about wearing out the relays anytime soon.

Conclusion

This simple and inexpensive modification to the ALS-500 and ALS-600 turns these amplifiers into true QSK amplifiers, as well as eliminate reliability problems often reported with the original open-frame relays. You'll also wind up with quieter T/R switching, a lower current keying requirement, and the ability to easily replace the relays should they ever fail. Spend an hour or so putting this all together. The results are well worth it!

Parts List: Sources are Mouser Electronics: www.mouser.com and All Electronics: www.allelectronics.com.

<u>QTY</u>	<u>Description</u>	<u>Source/Part Number</u>
2	Omron DPDT signal relays	Mouser 653-G6A-274P40-DC12
1	PC Board	AD5X
2	16-pin IC sockets	Mouser 535-16-3518-10
1	1N4003 diode	Mouser 512-1N4003
16"	#24 bus wire	McMaster-Carr 8871K42
16"	#20 bus wire	McMaster-Carr 8871K37
½"	1/16" heat shrink tubing	All Electronics HUG-116B

Note: An assembled printed circuit board plus the #20 and #24 bus wire and ½" heat-shrink tubing is available from the author for \$20 ppd. The relays must be purchased separately from Mouser.